



Green environment is our care! 



**Your water and composite
partner!**

2024

TRAIDENIS is:

- a market leader in the field of biotechnology and wastewater treatment;
- a company designing, manufacturing, installing and maintaining storage tanks and wastewater treatment plants;
- science, knowledge, innovations (“know – how”);
- an international company network;
- a modern production – technological base.



In 1996 ...



Today

FILAMENT WINDING TECHNOLOGY

Using cross filament winding system, the diameter of the manufactured tank bodies may vary from 0.6 m to 5.9 m.



AUTOMATED INDUSTRIAL CUTTING ROBOT

Industrial robot for part's trimming and drilling



SPRAY – UP, HAND LAY UP AND VACUUM TECHNOLOGIES



PRODUCT DESIGNING

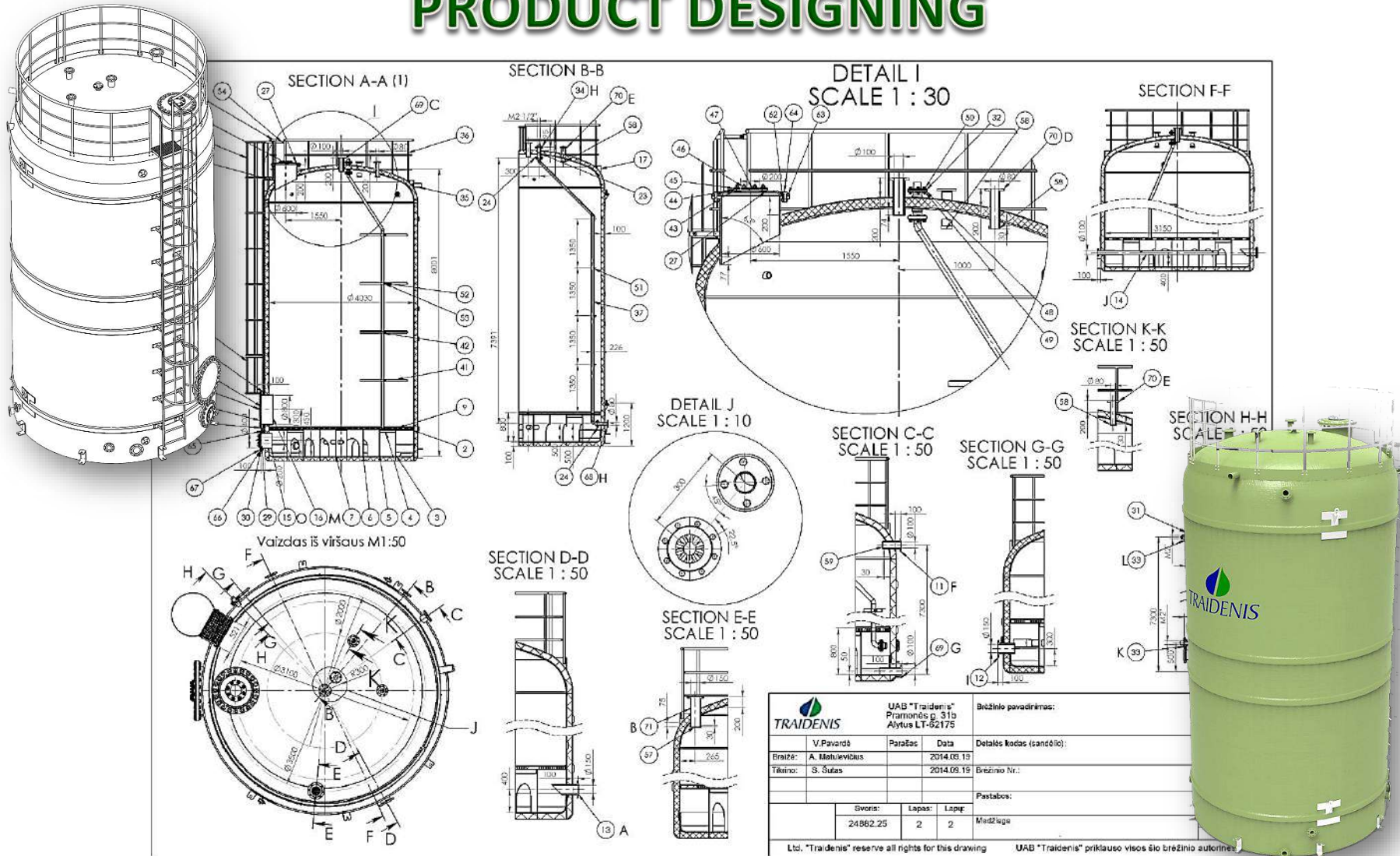

 UAB "Traidenis" Pramonės g. 31b Alytus LT-62175			Brėžinio pavadinimas:
V.Pavardė:	Parašas:	Data:	Detalės kodas (sandėlio):
Braižė: A. Mokuševičius	2014.06.19	2014.06.19	Brėžinio Nr.:
Tėkinio: S. Šušas			Pastabos:
Svoris: 24862.25	Lapas: 2	Lape: 2	Modifika:
Ltd. "Traidenis" reserve all rights for this drawing			UAB "Traidenis" priklauso visos šio brėžinio autoritetai

PRODUCT STRENGTH TESTING

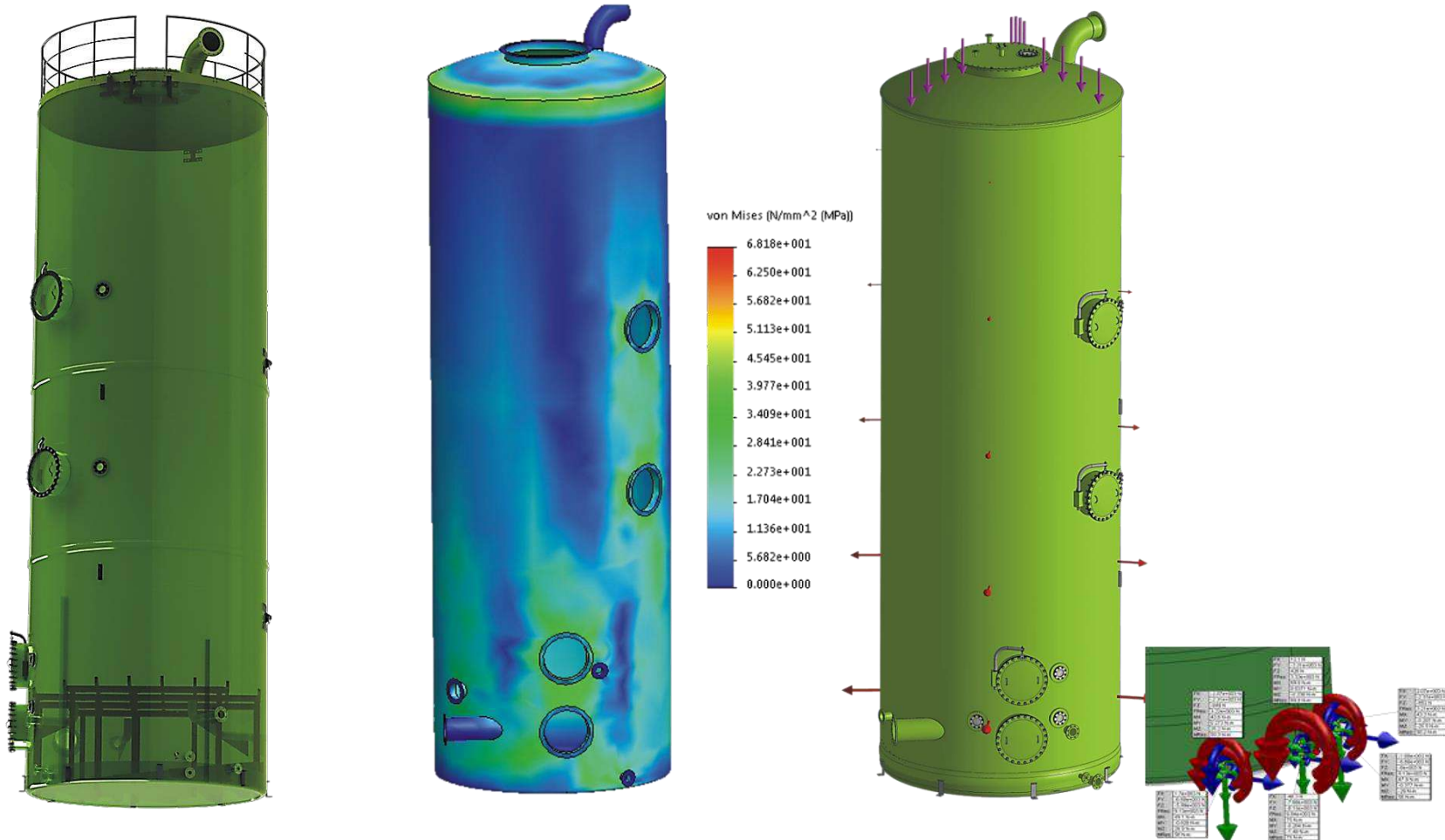

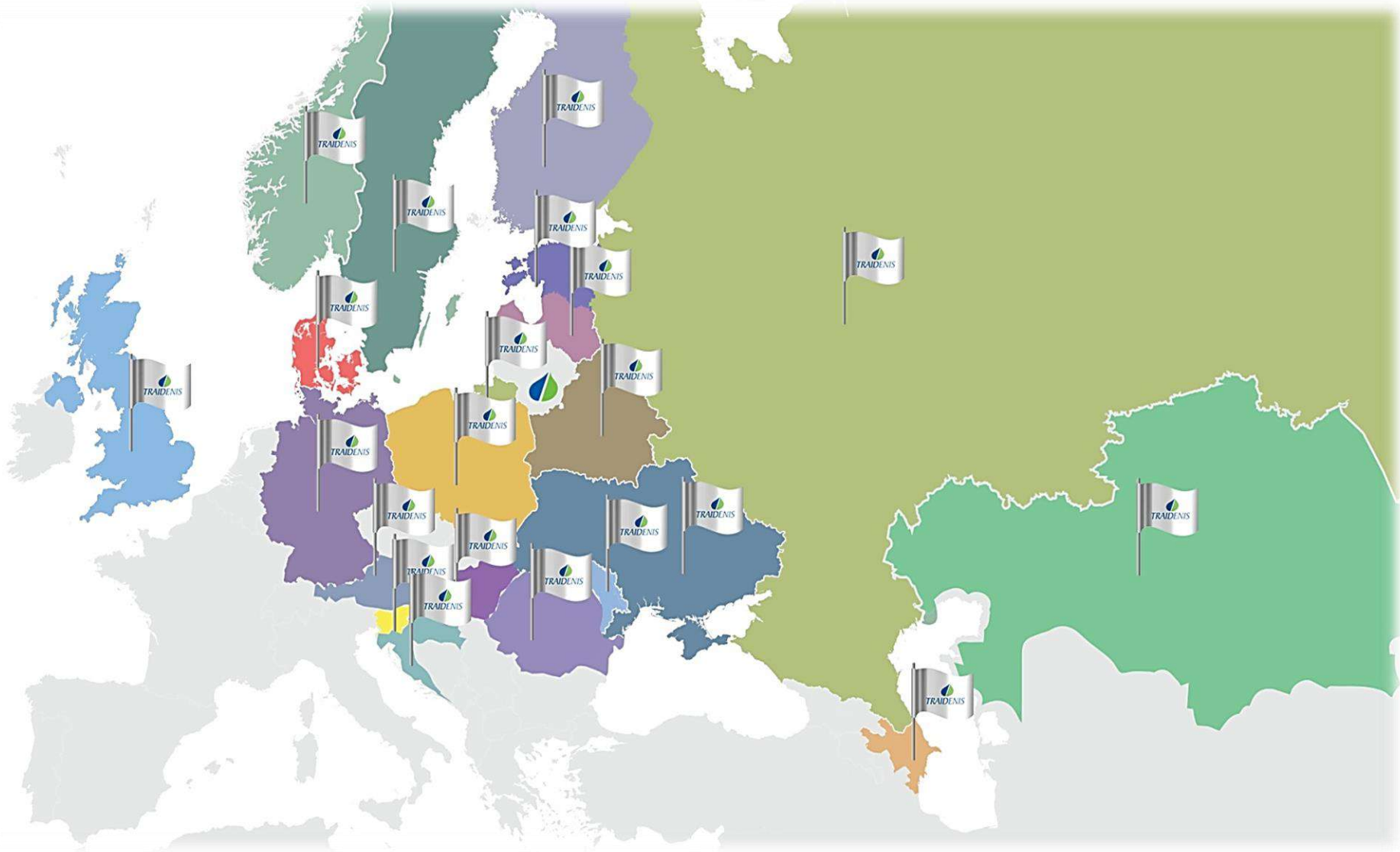

- Tanks from Glass-fibre Reinforced Plastic (GRP);
- Closed recirculating fish farming system;
- Wastewater treatment equipment;
- Other GRP products.



- Vertical and horizontal tanks
- Underground and overground tanks
- Single skin and multiple skin tanks
- Chemically resistant tanks
- Tanks for storage of fuel
- Tanks for drinking water
- Thermo-insulated tanks
- Scrubbers
- Modular tanks up to 5000 m³
- Dome-shaped modular roofs
- Firewater reservoirs

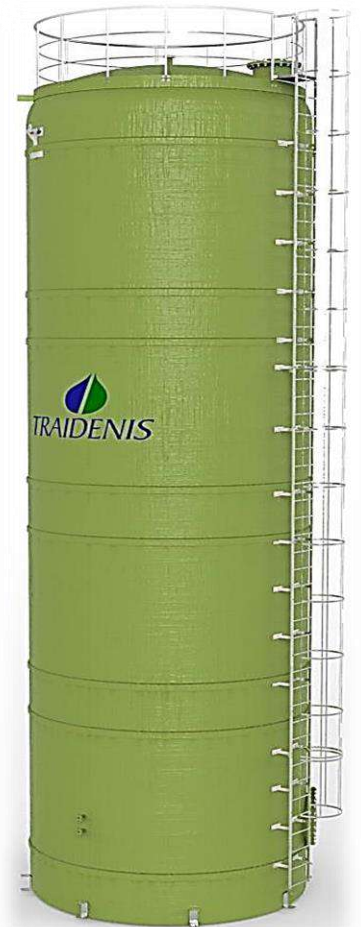

SINGLE AND DOUBLE WALLS

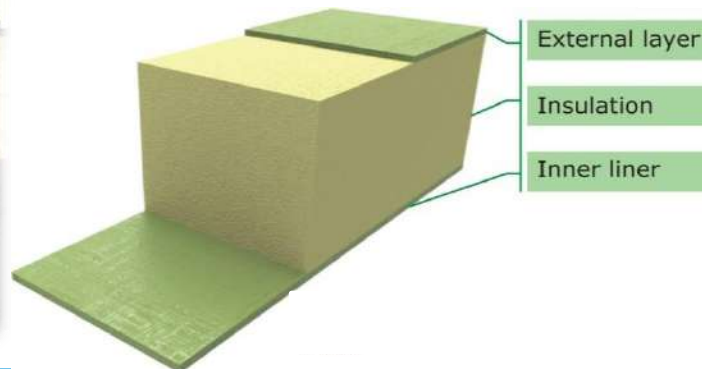
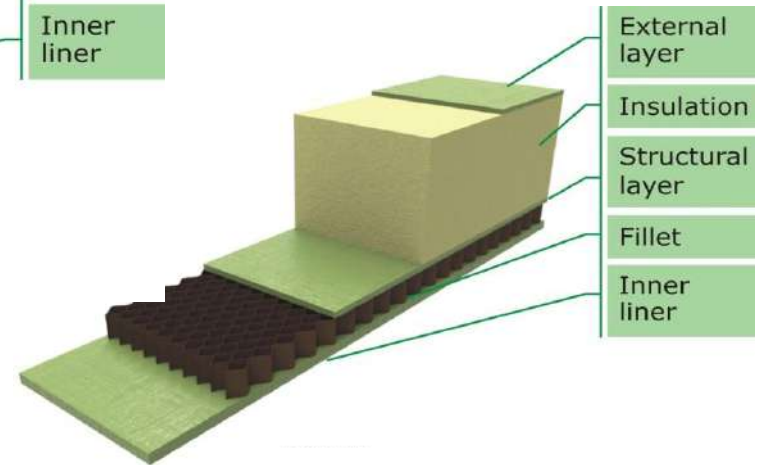
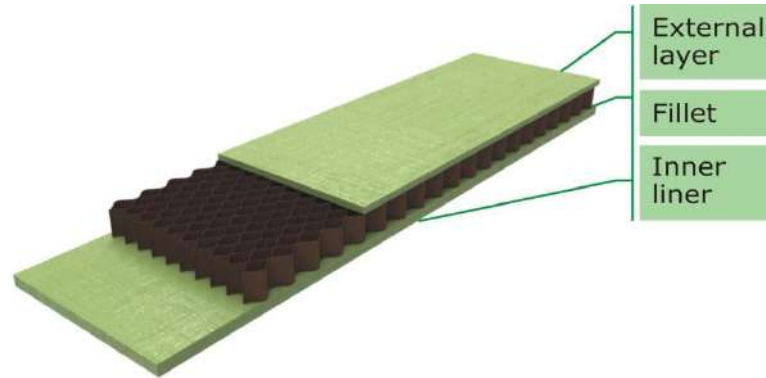

TANK 105 M³

HUNGARY



CHEMICALLY RESISTANT TANKS

LITHUANIA



CHEMICALLY RESISTANT TANKS 200 M³ (DN 5000 L 11000)

LITHUANIA



CHEMICALLY RESISTANT TANKS 200 M³ FOR KEEPING TECHNICAL WATER

RUSSIA



TANK 50 M³
FINLAND



**TANK
FOR SALT SOLUTION
GERMANY**



TANKS 15 M³

NORWAY



SCRUBBERS



**SCRUBBER
FOR BIOGAS POWER STATION
1,6 MW CAPACITY**

DENMARK



SCRUBBER
(DN 2100 H 6000)

GERMANY



SCRUBBERS

NORWAY



SCRUBBER
(DN 3500 H 12500)

NORWAY



SCRUBBER
(DN 5900 H 45000)
LITHUANIA



PUMP STATIONS

Pumping unit diameter is from DN1200 up to DN4000.
The height is specified by Customer, but typically < 12 m.

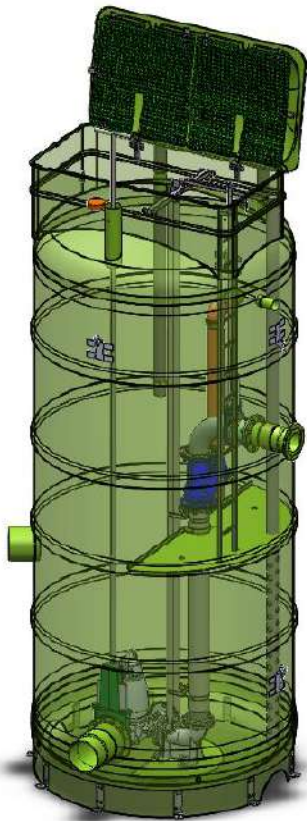

PUMP STATION

LITHUANIA



TANKS FOR KEEPING POWDERY SUBSTANCES

Tanks for keeping powdery substances are produced in various diameters and lengths, volume is from 1 m³ till 200 m³ and bigger.



TANK 50 M³ FOR KEEPING POWDERY SUBSTANCES

FINLAND



MODULAR TANKS TO 5000 M³ DOME-SHAPED MODULAR ROOFS

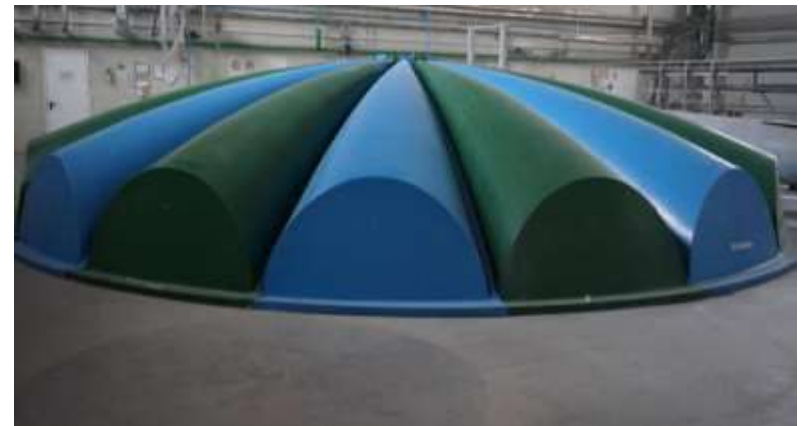

DOME-SHAPED MODULAR ROOF (DN 21,05 M)

LITHUANIA



**MODULAR TANK 100 M³
(DN 6,62 M H 4,91 M)**

NORWAY



**MODULAR TANK
(DN 5,85 M H 5,30 M)**

HUNGARY



FOR PRIVATE HOUSES UP TO 20 PT

FOR TOWNSHIPS UP TO 10 000 PT

**NV
TYPE**

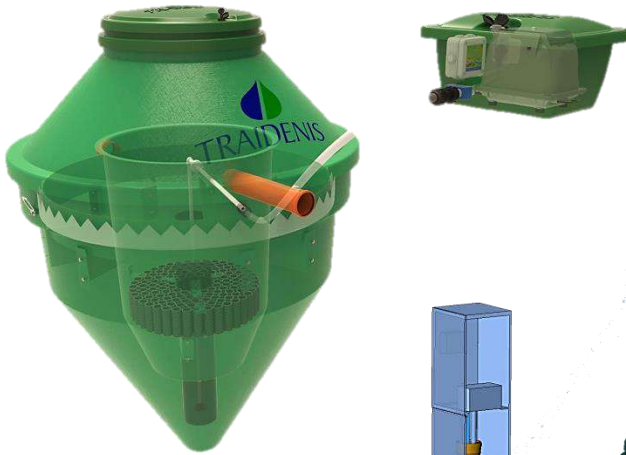

**NV-
COMFORT
TYPE**

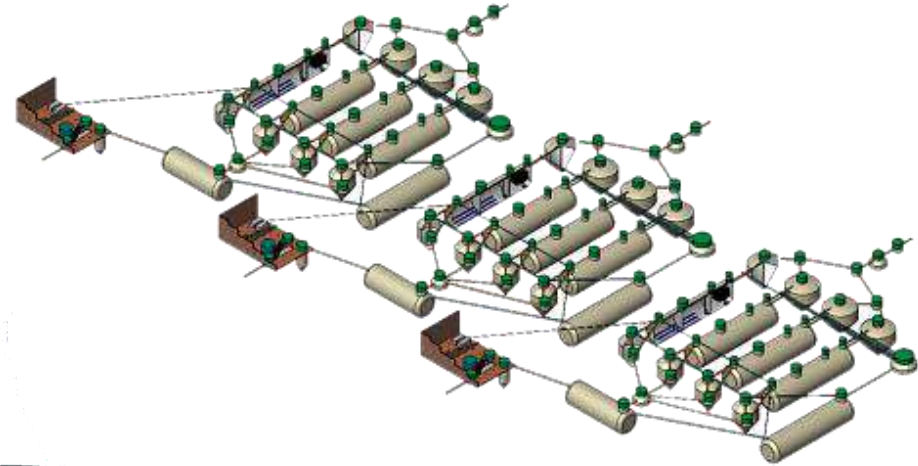
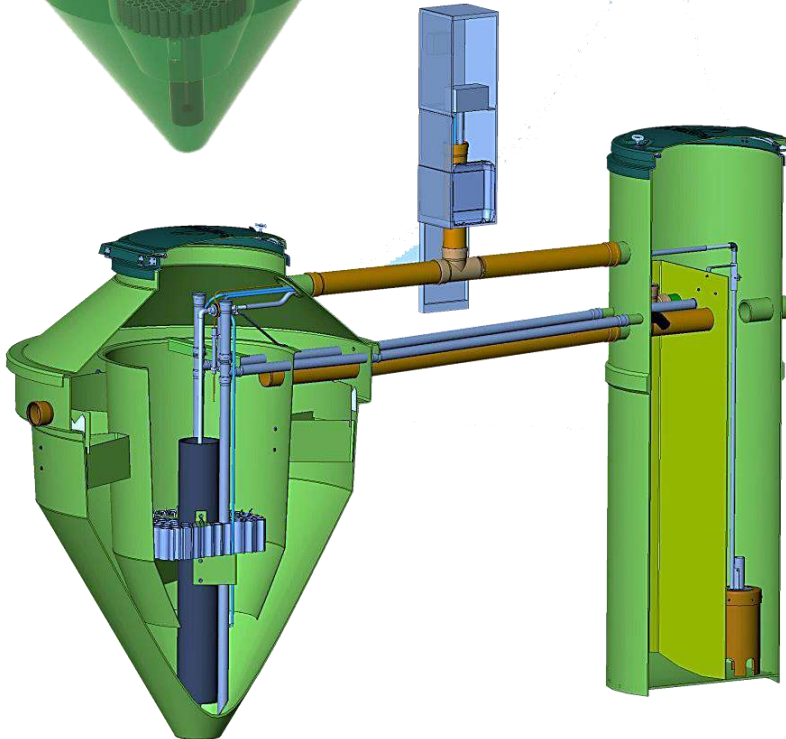

FOR INDUSTRY



**NV TYPE
WWT EQUIPMENT UP TO 20 PT**

POLAND



**NV-COMFORT TYPE
WWT EQUIPMENT UP TO 20 PT
SWEDEN**

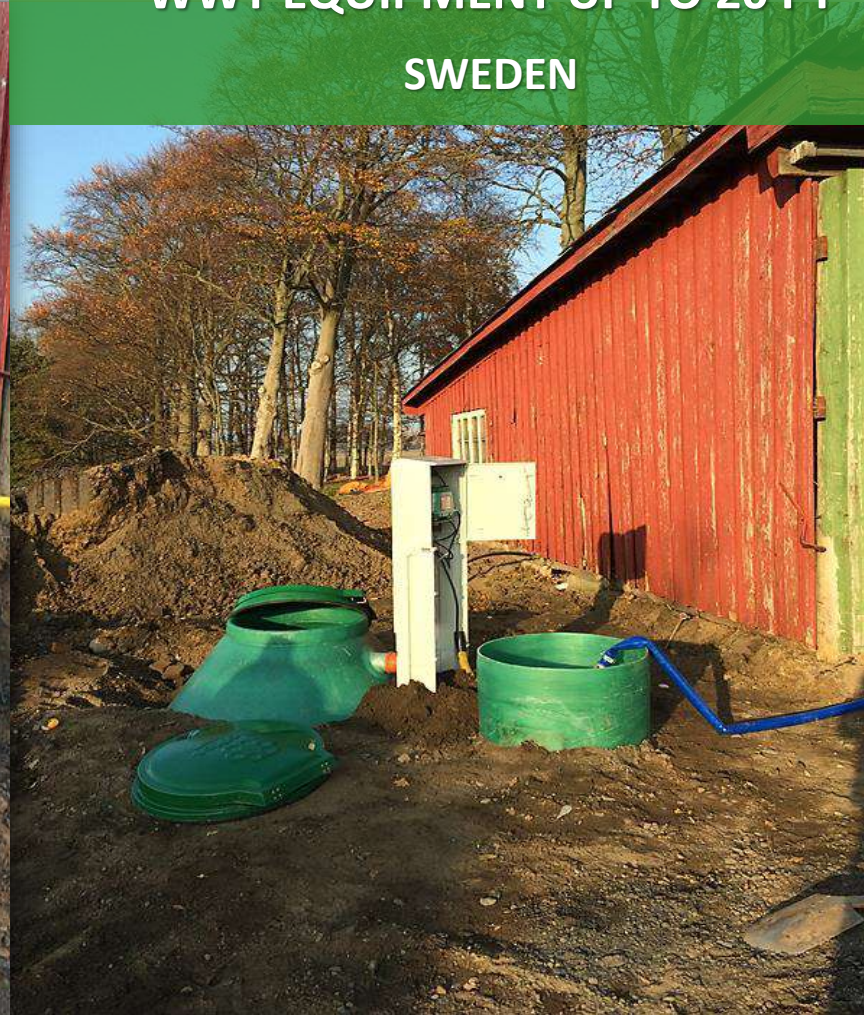

HNV TYPE FOR TOWNSHIPS



**500 M³/DAY CAPACITY
WWT EQUIPMENT**

RUSSIA



**300 M³/DAY CAPACITY
WWT EQUIPMENT**

POLAND



CLOSED RECIRCULATING FISH FARMING SYSTEM

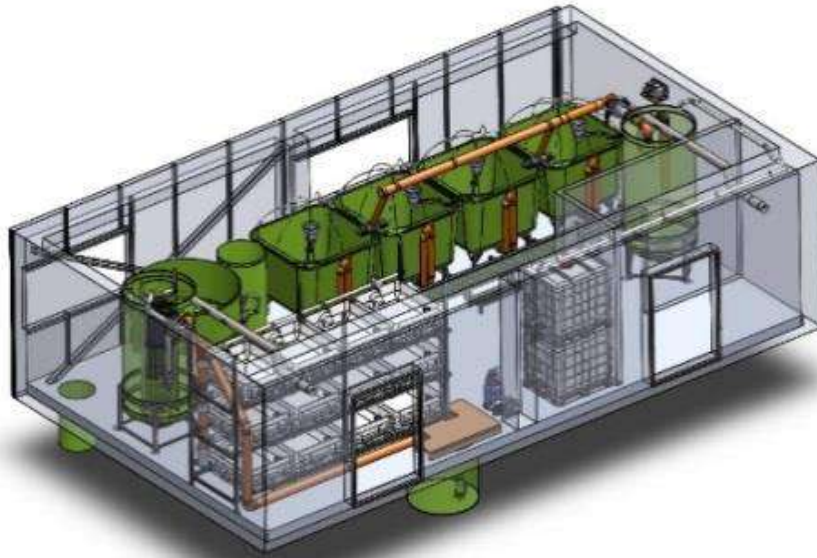

CLOSED RECIRCULATING FISH FARMING SYSTEM

LITHUANIA



NATO PROJECT



DNV·GL

MANAGEMENT SYSTEM CERTIFICATE

Certificate No: 334024-2014-AB-LTU-FPM&E Initial certification date: 24 April 2014
UAB: 24 June 2018 - 30 April 2020

This is to certify that the management system of

UAB TRaidENIS
Pramonės g. 31B, LT-62175, Alytus, Lithuania





has been found to conform to the Quality Management System standard:
ISO 9001:2015

This certificate is valid for the following scope:
DESIGN AND MANUFACTURE OF WASTE WATER TREATMENT PLANTS.

Issue date:
Kaunas, 24 June, 2018

For this issuing office:
DNV GL Business Assurance
Poland - by AB

For the signatory:
DNV GL Business Assurance
Iceland - by AB



UAB in fulfillment of its obligations under the Certification Agreement has issued this Certificate in full accordance with DNV GL Business Assurance Standard EN ISO 14001:2015. For more information, contact: info@dnv-gl.com

ISO 9001:2015

DNV·GL

MANAGEMENT SYSTEM CERTIFICATE

Certificate No: 334024-2014-AB-LTU-FPM&E Initial certification date: 24 April 2014
UAB: 24 June 2018 - 30 April 2020

This is to certify that the management system of



UAB TRaidENIS
Pramonės g. 31B, LT-62175, Alytus, Lithuania

has been found to conform to the Environmental Management System standard:
ISO 14001:2015

This certificate is valid for the following scope:
DESIGN AND MANUFACTURE OF WASTE WATER TREATMENT PLANTS.

Issue date:
Kaunas, 24 June, 2018

For the signatory:
DNV GL Business Assurance
Iceland - by AB



UAB in fulfillment of its obligations under the Certification Agreement has issued this Certificate in full accordance with DNV GL Business Assurance Standard EN ISO 14001:2015. For more information, contact: info@dnv-gl.com

ISO 14001:2015

SPSC STATYBOS PRODUKCIJOS CERTIFIKAVIMO CENTRAS
Liekėnų g. 28, LT-08217 Vilnius, Lietuvos Respublika

CERTIFICATE OF CONFORMITY OF PRODUCTION CONTROL

Product	glass reinforced plastic (GRP) cylindrical tanks
Type	single skin and double skin, overground and underground, horizontal and vertical
Intended use(s)	for the containment of granular solids and liquids
Manufacturer	UAB "Traidenis", Pramonės g. 31B, LT-62175 Alytus, Lithuania
Manufacturing plant	UAB "Traidenis", Pramonės g. 31B, LT-62175 Alytus, Lithuania
Requirements	NTI-01-058:2016

This certificate is issued having performed actions prescribed for system 2+ in STR 1.01.04:2015 and confirms that the factory production control complies with requirements set out in this certificate.

Number	SPSC-9326
Date of issue	2017-10-06 (first time issued on 2014-10-06)
Valid until	2020-10-06 (information: www.spssc.lt)
Granted to	UAB "Traidenis", Pramonės g. 31B, LT-62175 Alytus, Lithuania, company code 249910930

Director  **Robertas Encius**



Copy No. 1/24

**Certificate of conformity
of production control**

- „Product of the Year of Lithuania“;
- „The most Environmentally Friendly Product“;
- „Successfully Working Enterprise“;
- „National prize of Quality“;
- „Prize of Innovations“;
- „The best exporter of the year of Lithuanian Industrialists“, and etc.



- „Quality of the Year “ (Poland);
- „Product of the Year“ (Poland);
- „Product Quality and Innovations“ (Poland);
- European Quality Center ECO (Green) Certificate (Poland);
- „Golden key“ (Poland);
- „Responsibility for the future“ (Germany);
- „Company - favorite“ (Russia), and etc.





TRAIDENIS UAB
PRAMONĖS STR. 31B
LT-62175 ALYTUS,
LITHUANIA